

WEATHERPROOF LIGHT



WP L'illuminazione stradale è una scelta economica e sostenibile per le città di oggi. progettazione della distribuzione della luce, fornire rapidamente soluzioni di illuminazione. Controlla efficacemente la fuoriuscita, la perdita di luce, l'uniformità e la distribuzione della luce.

WP is Ceiling and wall-mounted luminaires for damp or corrosive environments and sheltered outdoor areas; also recommended for severe mechanical stability demands .with different wattage, lumen, beam angle, CRI, and CCT option

TECHNICAL DATA

Type	Weatherproof
Installation	Surface
Housing	Polycarbonate
Processing	Powder Coated
Diffuser	Tempered glass diffuser
Emergency Unit	On request
Light Emission Direction	Symmetrical
Glow Wire Test	850°
Safety Class	1
Direct Mounting on Normal Flammable Surface	Yes
Driver Included	Yes
Adjustable	No
Lifetime	60K hours

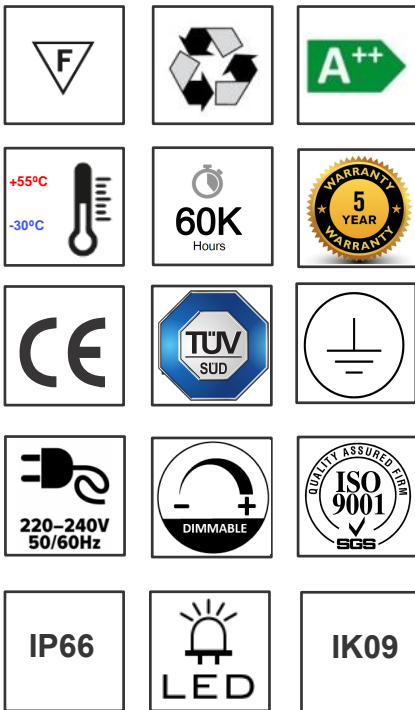

ORDERING CODE

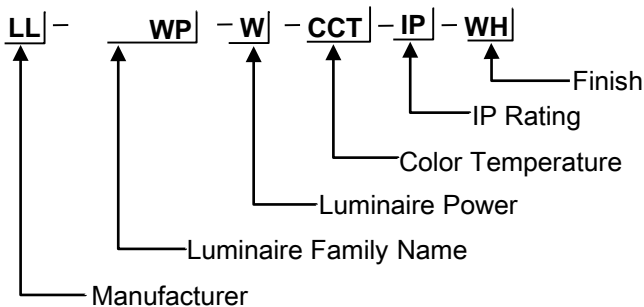

Code No.	System Power (W)	Lumen Output (lm)	Luminaire Efficacy (lm/W)	CRI
<input type="checkbox"/> WP-30W	30	3300	110	>90
<input type="checkbox"/> WP-35W	35	3850	110	>90
<input type="checkbox"/> WP-40W	40	4400	110	>90
<input type="checkbox"/> WP-45W	45	4950	110	>90
<input type="checkbox"/> WP-50W	50	5500	110	>90
<input type="checkbox"/> WP-60W	60	6600	110	>90

COLOR TEMPERATURE OPTION





- 2700K
 3000K
 4000K
 5000K
 6000K

BEAM ANGLE OPTION

- 5°
 18°
 24°
 36°
 45°
 60°
 90°
 120°
 Diffused



CONTROL OPTION

- DD DALI DIM 
 D1 0-10V DIM 
 PD Phase Cut DIM 
 D0 ON/OFF



LED CHIPS



LED DRIVERS



FINISH OPTION

- WH- White 
 BR- Black 

PHOTOMETRIC

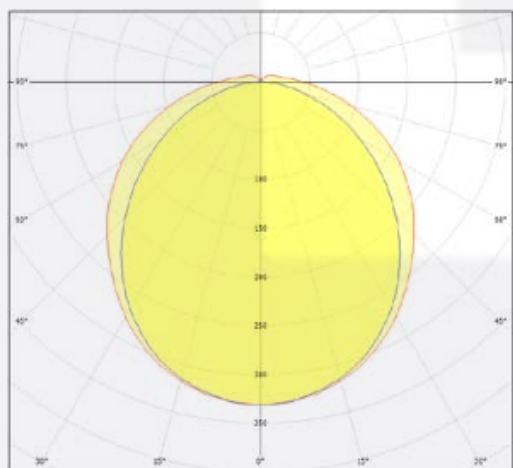

DIMENSION

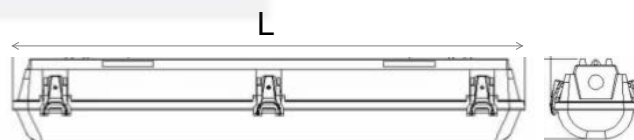

L.1160mm

NOTE: LED CHIPS & LED DRIVERS as per manufacturer's recommendations.