



SPIKE / PROJECTOR LIGHT



 **FLT21** is perfect for highlighting features on buildings or in flagpole. High power LED light source for the waterproofed, powerful, versatile spotlight, mounted on ground spike. Its compact size makes this light fitting ideally suited to any number of applications.

 **FLT21** è perfetto per evidenziare le caratteristiche degli edifici o nell'asta della bandiera. Sorgente luminosa a LED ad alta potenza per faretto impermeabile, potente e versatile, montato su picchetto da terra. Le sue dimensioni compatte rendono questo apparecchio di illuminazione ideale per qualsiasi numero di applicazioni.

TECHNICAL DATA

Type	Flood Light
Installation	Surface
Housing	Die-cast aluminium
Processing	Powder Coated
Diffuser	Safety Glass
Glow wire test	850°
Safety Class	II
Direct Mounting on Normal Flammable Surface	Yes
Driver Included	Yes
Adjustable	Yes

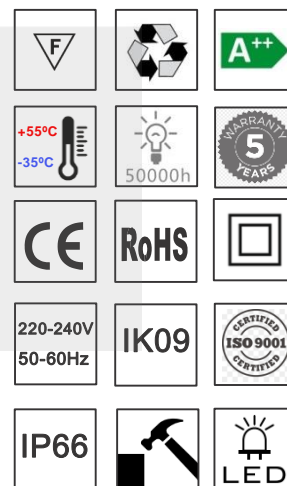

ORDERING CODE

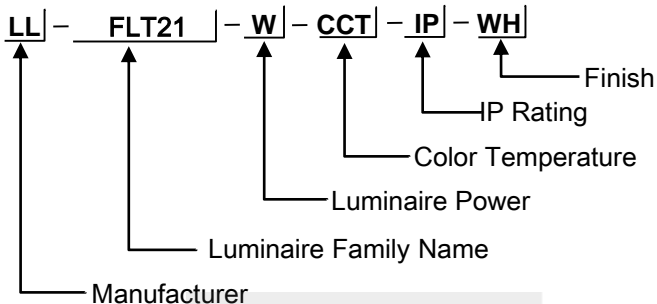

Code No.	System Power (W)	Lumen Output (lm)	Luminaire Efficacy (lm/W)	CRI
<input type="checkbox"/> FLT21	1.5	165	110	>90
<input type="checkbox"/> FLT21	2.0	220	110	>90
<input type="checkbox"/> FLT21	3.5	385	110	>90
<input type="checkbox"/> FLT21	5.0	550	110	>90

COLOR TEMPERATURE OPTION

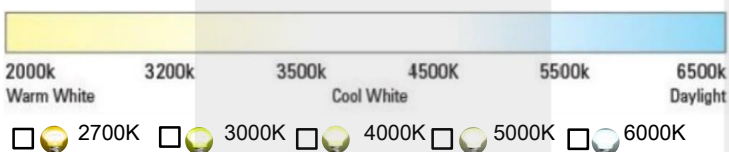

BEAM ANGLE OPTION



FINISH OPTION



CONTROL OPTION

- DD DALI DIM
- D1 0-10V DIM
- PD Phase Cut DIM
- DO On / Off

LED CHIPS



LED DRIVERS



TRIDONIC



DONE



TCI^{LED}
professional led applications

PHILIPS

Helvar

OSRAM

PHOTOMETRIC

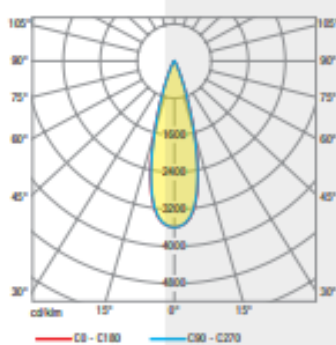
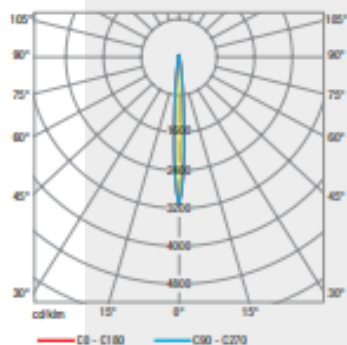

DIMENSION



Unit: mm

ACCESSORIES



45° Cylindrical Screen



Honeycomb Louvre



Spike for
Ground Installation