





White/Gold

White/Black

Black/White

 **CS03** is a surface Ceiling-mounted luminaire wire to the base with a pluggable connection for easy installation of different wattage, lumen, beam angle, CRI, and CCT option.

 **CS03** è un apparecchio per montaggio a soffitto di superficie, cavo alla base con una connessione a innesto per una facile installazione di diverse opzioni di wattaggio, lumen, angolo del fascio, CRI e CCT.

TECHNICAL DATA

Type	Square Downlight
Installation	Surface
Housing	Die-cast Aluminum
Processing	Powder Coated
Diffuser	Tempered Safety Glass
Light Emission Direction	Symmetrical
Glow wire test	850°
Safety Class	I
Direct Mounting on Normal Flammable Surface	Yes
Driver Included	Built-in
Adjustable	Fixed

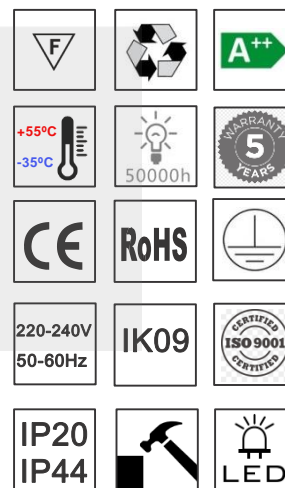

ORDERING CODE

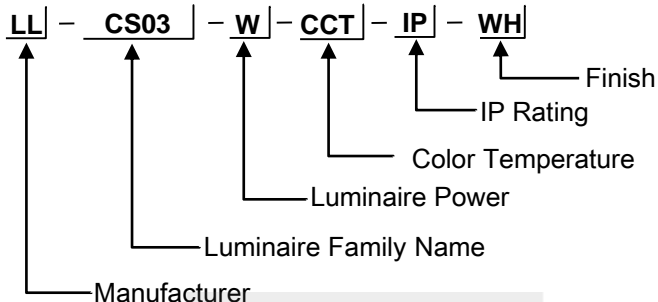

COLOR TEMPERATURE OPTION

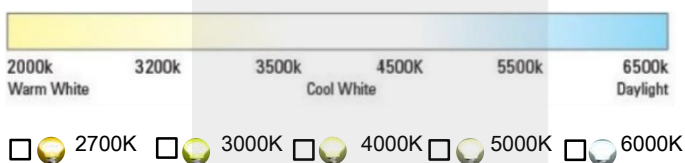

BEAM ANGLE OPTION

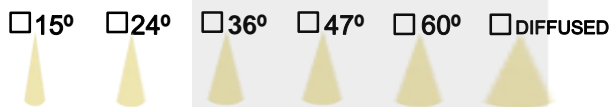

FINISH OPTION

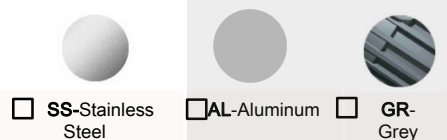

CONTROL OPTION

- DD** DALI DIM
- D1** 0-10V DIM
- PD** Phase Cut DIM
- D0** On. Off

LED CHIPS



Code No.	System Power (W)	Lumen Output (lm)	Luminaire Efficacy (lm/W)	CRI
<input type="checkbox"/> CS03-3X5W	3X5	1500	100	>90
<input type="checkbox"/> CS03-3X7W	3X7	2100	100	>90
<input type="checkbox"/> CS03-3X9W	3X9	2700	100	>90
<input type="checkbox"/> CS03-3X12W	3X12	3600	100	>90
<input type="checkbox"/> CS03-2X14W	3X14	4200	100	>90

Code No.	System Power (W)	Lumen Output (lm)	Luminaire Efficacy (lm/W)	CRI
<input type="checkbox"/> CS03-3X5W	3X5	1650	110	>95
<input type="checkbox"/> CS03-3X7W	3X7	2310	110	>95
<input type="checkbox"/> CS03-3X9W	3X9	2970	110	>95
<input type="checkbox"/> CS03-3X12W	3X12	3960	110	>95
<input type="checkbox"/> CS03-3X14W	3X14	4620	110	>95

LED DRIVERS



TRIDONIC



DONE



TCI LED
professional led applications

PHILIPS

HEP ower for light®

Helvar

OSRAM

PHOTOMETRIC

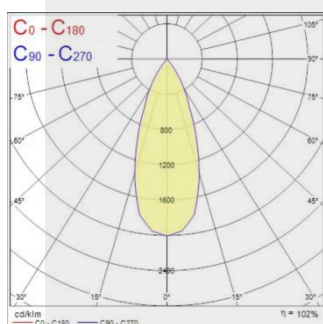

DIMENSION

